



+2.7V to +5.5V, Low-Power, Quad, Parallel 8-Bit DAC with Rail-to-Rail Voltage Outputs

MAX5100

General Description

The MAX5100 parallel-input, voltage-output, quad 8-bit digital-to-analog converter (DAC) operates from a single +2.7V to +5.5V supply and comes in a space-saving 20-pin TSSOP package. Internal precision buffers swing Rail-to-Rail®, and the reference input range includes both ground and the positive rail. All four DACs share a common reference input.

The MAX5100 provides double-buffered logic inputs: four 8-bit buffer registers followed by four 8-bit DAC registers. This keeps the DAC outputs from changing during the write operation. An asynchronous control pin, $\overline{\text{LDAC}}$, allows for simultaneous updating of the DAC registers.

The MAX5100 features a shutdown mode that reduces current to 1nA, as well as a power-on reset mode that resets all registers to code 00 hex on power-up.

Applications

Digital Gain and Offset Adjustments
 Programmable Attenuators
 Portable Instruments
 Power-Amp Bias Control

Features

- ◆ +2.7V to +5.5V Single-Supply Operation
- ◆ Ultra-Low Supply Current
0.4mA while Operating
1nA in Shutdown Mode
- ◆ Ultra-Small 20-Pin TSSOP Package
- ◆ Ground to V_{DD} Reference Input Range
- ◆ Output Buffer Amplifiers Swing Rail-to-Rail
- ◆ Double-Buffered Registers for Synchronous Updating
- ◆ Power-On Reset Sets All Registers to Zero

Ordering Information

PART	TEMP. RANGE	PIN-PACKAGE	INL (LSB)
MAX5100AEUP	-40°C to +85°C	20 TSSOP	±1
MAX5100BEUP	-40°C to +85°C	20 TSSOP	±2

Pin Configuration

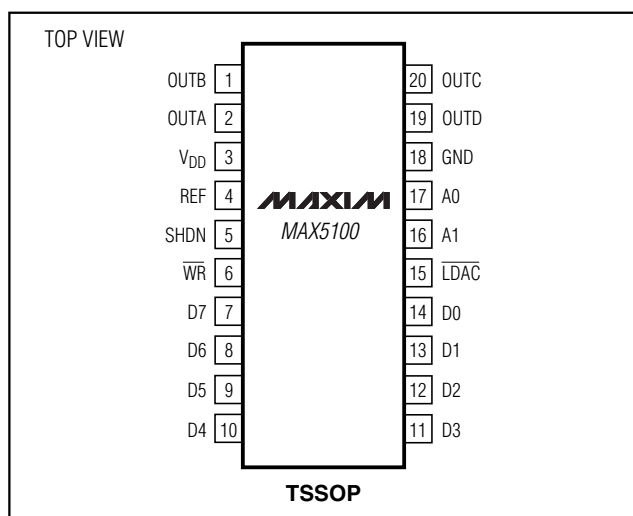

Rail-to-Rail is a registered trademark of Nippon Motorola, Ltd.



Maxim Integrated Products 1

For free samples & the latest literature: <http://www.maxim-ic.com>, or phone 1-800-998-8800.
 For small orders, phone 1-800-835-8769.

+2.7V to +5.5V, Low-Power, Quad, Parallel 8-Bit DAC with Rail-to-Rail Voltage Outputs

ABSOLUTE MAXIMUM RATINGS

V _{DD} to GND	-0.3V to +6V
D ₋ , A ₋ , $\overline{\text{WR}}$, SHDN, $\overline{\text{LDAC}}$ to GND	-0.3V to +6V
REF to GND	-0.3V to (V _{DD} + 0.3V)
OUT ₋ to GND	-0.3V to V _{DD}
Maximum Current into Any Pin	±50mA
Continuous Power Dissipation (T _A = +70°C)	
20-Pin TSSOP (derate 7.0mW/°C above +70°C)559mW

Operating Temperature Range	
MAX5100_EUP	-40°C to +85°C
Maximum Junction Temperature	+150°C
Storage Temperature Range	-65°C to +150°C
Lead Temperature (soldering, 10sec)	+300°C

Stresses beyond those listed under "Absolute Maximum Ratings" may cause permanent damage to the device. These are stress ratings only, and functional operation of the device at these or any other conditions beyond those indicated in the operational sections of the specifications is not implied. Exposure to absolute maximum rating conditions for extended periods may affect device reliability.

ELECTRICAL CHARACTERISTICS

(V_{DD} = V_{REF} = +2.7V to +5.5V, R_L = 10kΩ, C_L = 100pF, T_A = T_{MIN} to T_{MAX}, unless otherwise noted. Typical values are at V_{DD} = V_{REF} = +3V and T_A = +25°C.)

PARAMETER	SYMBOL	CONDITIONS	MIN	TYP	MAX	UNITS
STATIC ACCURACY						
Resolution					8	Bits
Integral Nonlinearity (Note 1)	INL	MAX5100A			±1	LSB
		MAX5100B			±2	
Differential Nonlinearity (Note 1)	DNL	Guaranteed monotonic			±1	LSB
Zero-Code Error	ZCE	Code = 00 hex			±20	mV
Zero-Code-Error Supply Rejection		Code = 00 hex, V _{DD} = 2.7V to 5.5V			10	mV
Zero-Code Temperature Coefficient		Code = 00 hex		±10		μV/°C
Gain Error (Note 2)		Code = F0 hex			±1	%
Gain-Error Temperature Coefficient		Code = F0 hex		±0.001		LSB/°C
Power-Supply Rejection		Code = FF hex	V _{DD} = 2.7V to 3.6V, V _{REF} = 2.5V		1	LSB
			V _{DD} = 4.5V to 5.5V, V _{REF} = 4.096V		1	
REFERENCE INPUT						
Input Voltage Range			0		V _{DD}	V
Input Resistance			320	460	600	kΩ
Input Capacitance				15		pF
DAC OUTPUTS						
Output Voltage Range		R _L = ∞	0		V _{REF}	V
DIGITAL INPUTS						
Input High Voltage	V _{IH}	V _{DD} = 2.7V to 3.6V	2			V
		V _{DD} = 3.6V to 5.5V	3			
Input Low Voltage	V _{IL}				0.8	V
Input Current	I _{IN}	V _{IN} = V _{DD} or GND			±1.0	μA
Input Capacitance	C _{IN}			10		pF

+2.7V to +5.5V, Low-Power, Quad, Parallel 8-Bit DAC with Rail-to-Rail Voltage Outputs

MAX5100

ELECTRICAL CHARACTERISTICS (continued)

($V_{DD} = V_{REF} = +2.7V$ to $+5.5V$, $R_L = 10k\Omega$, $C_L = 100pF$, $T_A = T_{MIN}$ to T_{MAX} , unless otherwise noted. Typical values are at $V_{DD} = V_{REF} = +3V$ and $T_A = +25^\circ C$.)

PARAMETER	SYMBOL	CONDITIONS		MIN	TYP	MAX	UNITS
DYNAMIC PERFORMANCE							
Output Voltage Slew Rate		From code 00 to code F0 hex			0.6		V/ μ s
Output Settling Time (Note 3)		To 1/2LSB, from code 10 to code F0 hex			6		μ s
Channel-to-Channel Isolation (Note 4)		Code 00 to code FF hex			500		nVs
Digital Feedthrough (Note 5)		Code 00 to code FF hex			0.5		nVs
Digital-to-Analog Glitch Impulse		Code 80 hex to code 7F hex			90		nVs
Signal-to-Noise plus Distortion Ratio	SINAD	$V_{REF(DC)} = 1.5V$, $V_{DD} = 3V$, code = FF hex	REF = 2.5Vp-p at 1kHz		70		dB
			REF = 2.5Vp-p at 10kHz		60		
Multiplying Bandwidth		REF = 0.5Vp-p, $V_{REF(DC)} = 1.5V$, $V_{DD} = 3V$, -3dB bandwidth			650		kHz
Wideband Amplifier Noise					60		μ V _{RMS}
Shutdown Recovery Time	t_{SDR}	To $\pm 1/2$ LSB of final value of V_{OUT}			13		μ s
Time to Shutdown	t_{SDN}	$I_{DD} < 5\mu A$			20		μ s
POWER SUPPLIES							
Power-Supply Voltage	V_{DD}			2.7		5.5	V
Supply Current (Note 6)	I_{DD}				370	700	μ A
Shutdown Current					0.001	1	μ A
DIGITAL TIMING (Figure 1) (Note 7)							
Address to \overline{WR} Setup	t_{AS}			5			ns
Address to \overline{WR} Hold	t_{AH}			0			ns
Data to \overline{WR} Setup	t_{DS}			25			ns
Data to \overline{WR} Hold	t_{DH}			0			ns
\overline{WR} Pulse Width	t_{WR}			20			ns
\overline{LDAC} Pulse Width (Note 8)	t_{LD}			20			ns

Note 1: Reduced digital code range (code 00 hex to code F0 hex) due to swing limitations when the output amplifier is loaded.

Note 2: Gain error is: $[100 (V_{F0,meas} - ZCE - V_{F0,ideal}) / V_{REF}]$. Where $V_{F0,meas}$ is the DAC output voltage with input code F0 hex, and $V_{F0,ideal}$ is the ideal DAC output voltage with input code F0 hex (i.e., $V_{REF} \cdot 240 / 256$).

Note 3: Output settling time is measured from the 50% point of the falling edge of \overline{WR} to $\pm 1/2$ LSB of V_{OUT} 's final value.

Note 4: Channel-to-channel isolation is defined as the glitch energy at a DAC output in response to a full-scale step change on any other DAC output. The measured channel has a fixed code of 80 hex.

Note 5: Digital feedthrough is defined as the glitch energy at any DAC output in response to a full-scale step change on all eight data inputs with \overline{WR} at V_{DD} .

Note 6: $R_L = \infty$, digital inputs at GND or V_{DD} .

Note 7: Timing measurement reference level is $(V_{IH} + V_{IL}) / 2$.

Note 8: If \overline{LDAC} is activated prior to \overline{WR} 's rising edge, it must stay low for t_{LD} (or longer) after \overline{WR} goes high.

+2.7V to +5.5V, Low-Power, Quad, Parallel 8-Bit DAC with Rail-to-Rail Voltage Outputs

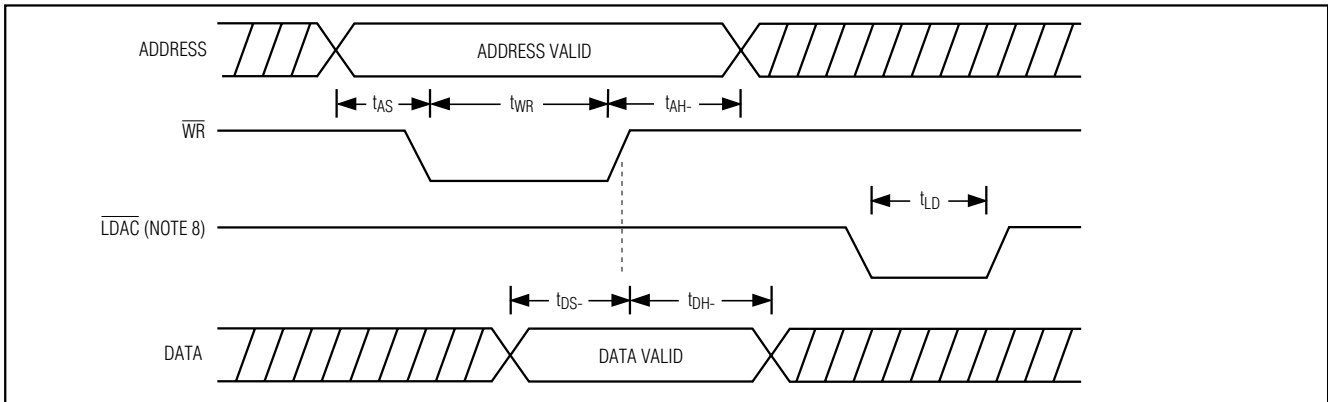
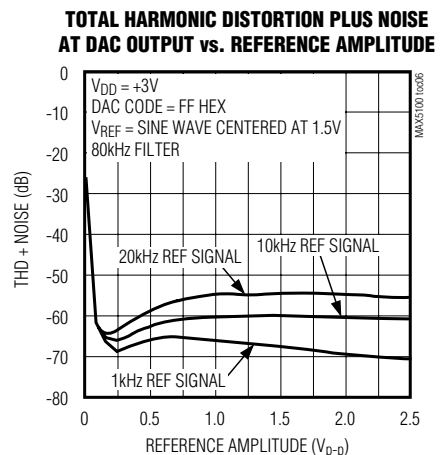
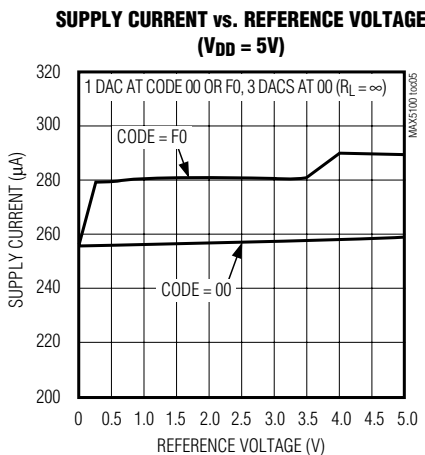
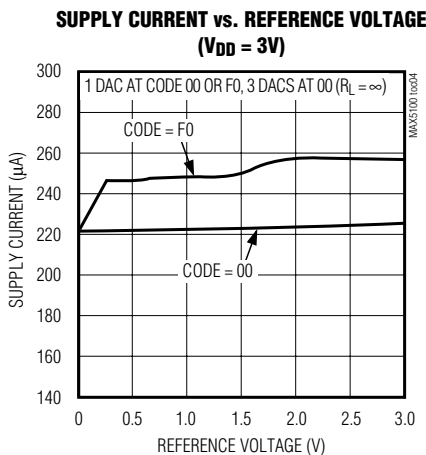
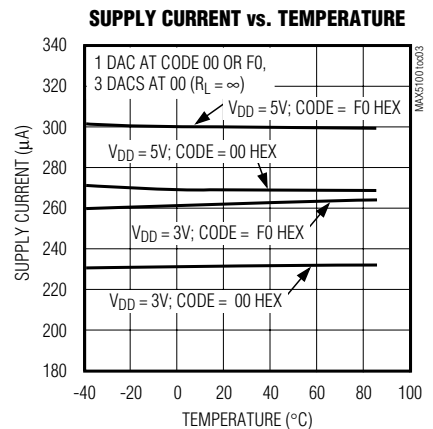
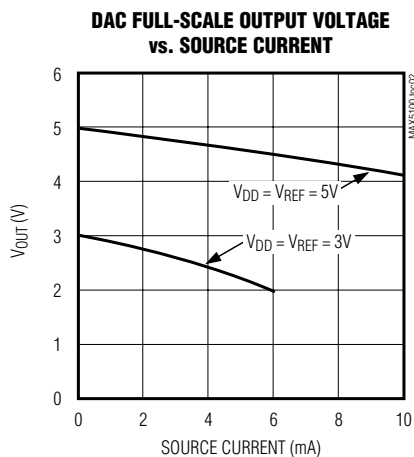
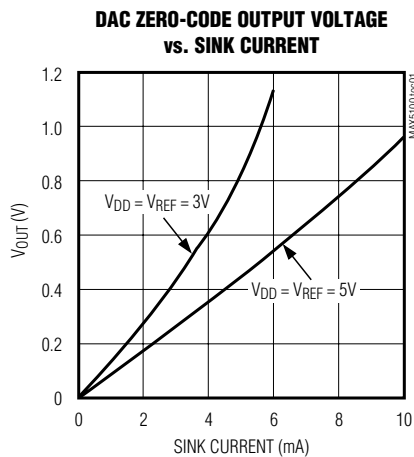

Figure 1. Timing Diagram

Typical Operating Characteristics

($V_{DD} = V_{REF} = +3V$, $R_L = 10k\Omega$, $C_L = 100pF$, code = FF hex, $T_A = +25^\circ C$, unless otherwise noted.)



+2.7V to +5.5V, Low-Power, Quad, Parallel 8-Bit DAC with Rail-to-Rail Voltage Outputs

Typical Operating Characteristics (continued)

($V_{DD} = V_{REF} = +3V$, $R_L = 10k\Omega$, $C_L = 100pF$, code = FF hex, $T_A = +25^\circ C$, unless otherwise noted.)

MAX5100

TOTAL HARMONIC DISTORTION PLUS NOISE AT DAC OUTPUT vs. REFERENCE FREQUENCY

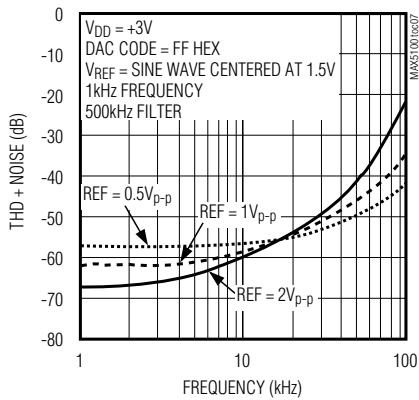

REFERENCE INPUT FREQUENCY RESPONSE

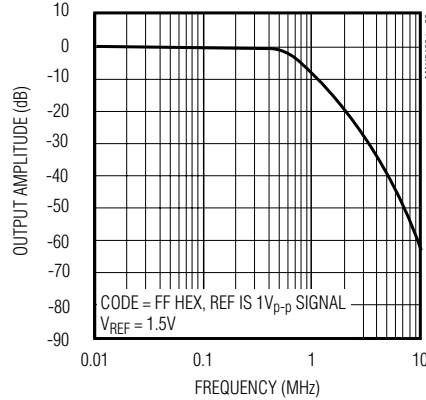

WORST-CASE 1LSB DIGITAL STEP CHANGE (NEGATIVE)

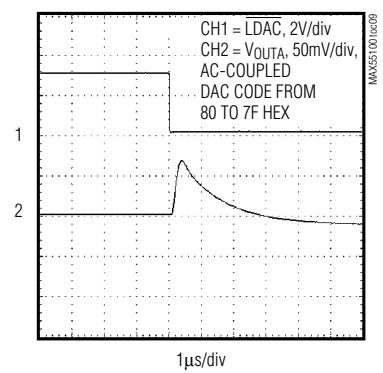

WORST-CASE 1LSB DIGITAL STEP CHANGE (POSITIVE)

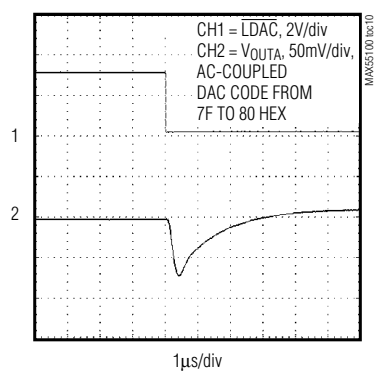

DIGITAL FEEDTHROUGH GLITCH IMPULSE (0 TO 1 DIGITAL TRANSITION)

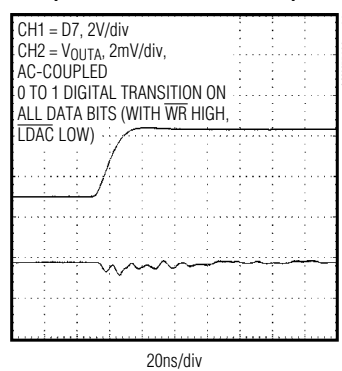

DIGITAL FEEDTHROUGH GLITCH IMPULSE (1 TO 0 DIGITAL TRANSITION)

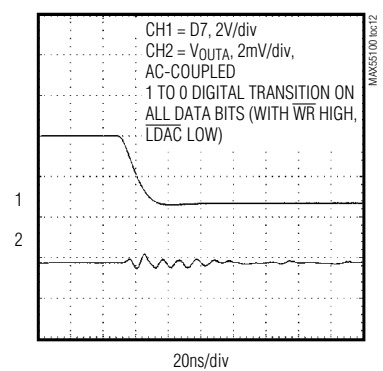

POSITIVE SETTLING TIME

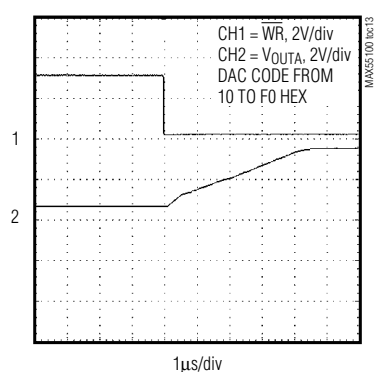

NEGATIVE SETTLING TIME

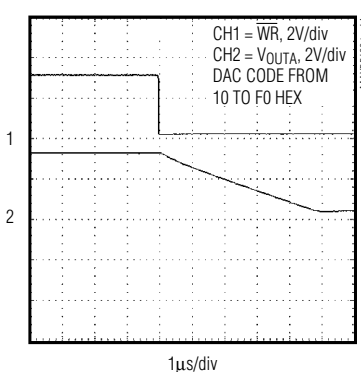

INTEGRAL AND DIFFERENTIAL NONLINEARITY vs. DIGITAL CODE

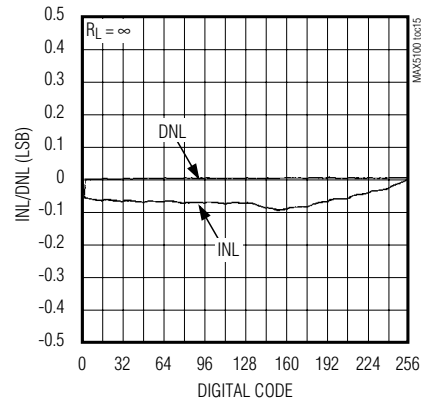

+2.7V to +5.5V, Low-Power, Quad, Parallel 8-Bit DAC with Rail-to-Rail Voltage Outputs

Pin Description

PIN	NAME	FUNCTION
1	OUTB	DAC B Voltage Output
2	OUTA	DAC A Voltage Output
3	VDD	Positive Supply Voltage. Bypass VDD to GND using a 0.1µF capacitor.
4	REF	Reference Voltage Input
5	SHDN	Shutdown. Connect SHDN to GND for normal operation.
6	\overline{WR}	Write Input (active low). Use \overline{WR} to load data into the DAC input latch selected by A0 and A1.
7–14	D7–D0	Data Inputs 7–0
15	\overline{LDAC}	Load DAC Input (active low). Drive the asynchronous \overline{LDAC} input low to transfer the contents of all input latches to their respective DAC latch.
16	A1	DAC Address Select Bit (MSB)
17	A0	DAC Address Select Bit (LSB)
18	GND	Ground
19	OUTD	DAC D Voltage Output
20	OUTC	DAC C Voltage Output

Detailed Description

Digital-to-Analog Section

The MAX5100 uses a matrix decoding architecture for the DACs. The external reference voltage is divided down by a resistor string placed in a matrix fashion. Row and column decoders select the appropriate tab from the resistor string to provide the needed analog voltages. The resistor network converts the 8-bit digital input into an equivalent analog output voltage in proportion to the applied reference voltage input. The resistor string presents a code-independent input impedance to the reference and guarantees a monotonic output.

The device can be used in multiplying applications. The voltages are buffered by rail-to-rail op amps connected in a follower configuration to provide a rail-to-rail output. The functional block diagram for the MAX5100 is shown in Figure 2.

Low-Power Shutdown Mode

The MAX5100 features a shutdown mode that reduces current consumption to 1nA. A high voltage on the shutdown pin shuts down the DACs and the output amplifiers. In shutdown mode, the output amplifiers enter a high-impedance state. When bringing the

device out of shutdown, allow 13µs for the output to stabilize.

Output Buffer Amplifiers

The DAC outputs are internally buffered by precision amplifiers with a typical slew rate of 0.6V/µs. The typical settling time to $\pm 1/2$ LSB at the output is 6µs when loaded with 10kΩ in parallel with 100pF.

Reference Input

The MAX5100 provides a code-independent input impedance on the REF input. The input impedance is typically 460kΩ in parallel with 15pF, and the reference input voltage range is 0 to VDD. The reference input accepts positive DC signals as well as AC signals with peak values between 0 and VDD. The voltage at REF sets the full-scale output voltage for the DAC. The output voltage (VOUT) for any DAC is represented by a digitally programmable voltage source as follows:

$$V_{OUT} = (N_B \cdot V_{REF}) / 256$$

where N_B is the numeric value of the DAC binary input code.

Digital Inputs and Interface Logic

In the MAX5100, address lines A0 and A1 select the DAC that receives data from D0–D7, as shown in Table 1.

+2.7V to +5.5V, Low-Power, Quad, Parallel 8-Bit DAC with Rail-to-Rail Voltage Outputs

MAX5100

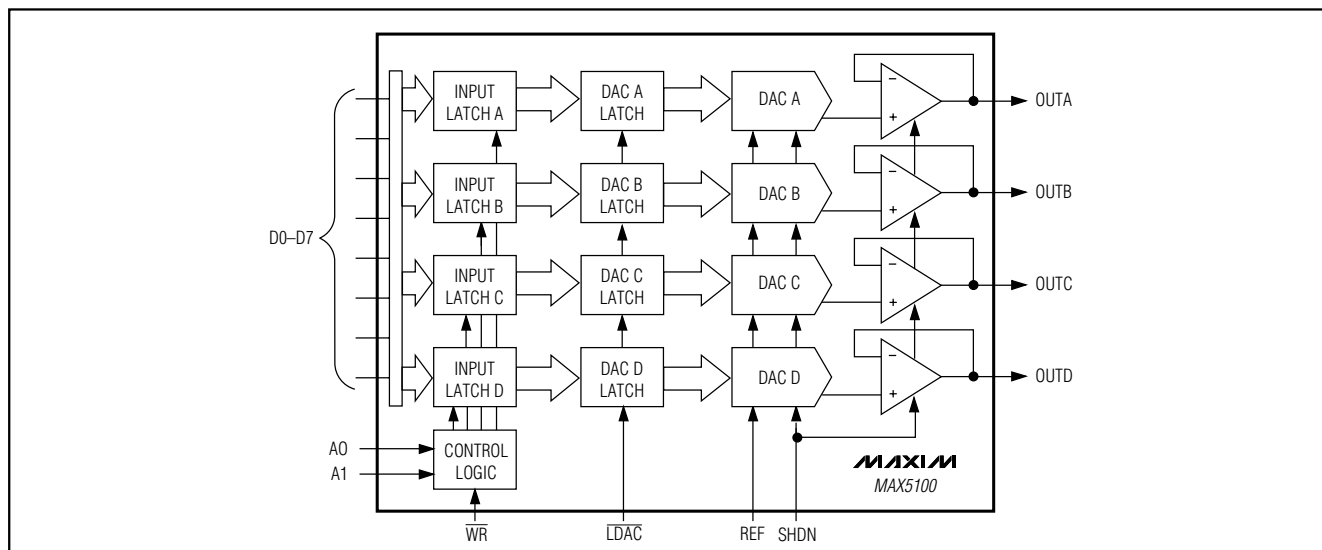

Figure 2. Functional Diagram

Table 1. MAX5100 Address Table (Partial)

$\overline{\text{LDAC}}$	$\overline{\text{WR}}$	A1	A0	LATCH STATE
H	H	X	X	Input and DAC data latched
H	L	L	L	DAC A input latch transparent
L	H	X	X	All 4 DACs' DAC latches transparent
L	L	L	L	DAC A input registers transparent and all 4 DACs' DAC latches transparent
H	L	L	H	DAC B input latch transparent
H	L	H	L	DAC C input latch transparent
H	L	H	H	DAC D input latch transparent

H = High state, L = Low state, X = Don't care

When $\overline{\text{WR}}$ is low, the addressed DAC's input latch is transparent. Data is latched when $\overline{\text{WR}}$ is high.

The MAX5100 $\overline{\text{LDAC}}$ feature allows simultaneous updating of all four DACs. $\overline{\text{LDAC}}$ low latches the data in the data registers to the DAC registers. If simultaneous updating is not required, tie $\overline{\text{LDAC}}$ low to keep the DAC latches transparent. If $\overline{\text{WR}}$ and $\overline{\text{LDAC}}$ are low simultaneously, avoid output glitches by ensuring that data is valid before the two signals go low. When the device powers up (i.e., V_{DD} ramps up), all latches are internally preset with code 00 hex.

Applications Information

External Reference

The reference source resistance must be considerably less than the reference input resistance. To keep within 1LSB error in an 8-bit system, R_S must be less than $R_{\text{REF}} / 256$. Hence, maintain a value of $R_S < 1\text{k}\Omega$ to ensure 8-bit accuracy. If V_{REF} is DC only, bypass REF to GND with a $0.1\mu\text{F}$ capacitor. Values greater than this improve noise rejection.

Power Sequencing

The voltage applied to REF should not exceed V_{DD} at any time. If proper power sequencing is not possible, connect an external Schottky diode between REF and V_{DD} to ensure compliance with the absolute maximum ratings.

Power-Supply Bypassing and Ground Management

Digital or AC transient signals on GND can create noise at the analog output. Return GND to the highest-quality ground available. Bypass V_{DD} with a $0.1\mu\text{F}$ capacitor, located as close to V_{DD} and GND as possible.

Careful PC board ground layout minimizes crosstalk between the DAC outputs and digital inputs.

Chip Information

TRANSISTOR COUNT: 6848

+2.7V to +5.5V, Low-Power, Quad, Parallel 8-Bit DAC with Rail-to-Rail Voltage Outputs

Package Information

COMMON DIMENSIONS				
	MILLIMETERS		INCHES	
	MIN.	MAX.	MIN.	MAX.
A	—	1.10	—	.043
A ₁	0.05	0.15	.002	.006
A ₂	0.85	0.95	.033	.037
b	0.19	0.30	.007	.012
b1	0.19	0.25	.007	.010
c	0.090	0.20	.0035	.008
c1	0.090	0.135	.0035	.0053
D	SEE VARIATIONS		SEE VARIATIONS	
E	4.30	4.50	.169	.177
e	0.65 BSC		.026 BSC	
H	6.25	6.50	.246	.256
L	0.50	0.70	.020	.028
N	SEE VARIATIONS		SEE VARIATIONS	
Y	2.85	3.15	.112	.124
α	0°	8°	0°	8°

JEDEC		VARIATIONS			
MD-153	N	MILLIMETERS		INCHES	
		MIN.	MAX.	MIN.	MAX.
AB	14 D	4.90	5.10	.193	.201
AC	16 D	4.90	5.10	.193	.201
AC-EP	16 D	4.90	5.10	.193	.201
	X	2.85	3.15	.112	.124
AD	20 D	6.40	6.60	.252	.260
AD-EP	20 D	6.40	6.60	.252	.260
	X	4.00	4.34	.157	.171
AE	24 D	7.70	7.90	.303	.311
AF	28 D	9.60	9.80	.378	.386
AF-EP	D	9.60	9.80	.378	.386
	X	5.35	5.65	.211	.222

NOTES:

- DIMENSIONS D AND E DO NOT INCLUDE FLASH.
- MOLD FLASH OR PROTRUSIONS NOT TO EXCEED .15 mm PER SIDE.
- CONTROLLING DIMENSION: MILLIMETER.
- MEETS JEDEC OUTLINE MD-153 VARIATIONS AB, AC, AD, AE, AF.
- DIMENSIONS X AND Y APPLY TO EXPOSED PAD (EP) VERSIONS ONLY.
- EXPOSED PAD FLUSH WITH BOTTOM OF PACKAGE WITHIN .002".

TSSOP-EP

PROPRIETARY INFORMATION
 TITLE: PACKAGE OUTLINE, TSSOP, 4.40mm BODY, 0.65mm PITCH
 APPROVAL: _____ DOCUMENT CONTROL NO. 21-0066 REV C 1/1

Maxim cannot assume responsibility for use of any circuitry other than circuitry entirely embodied in a Maxim product. No circuit patent licenses are implied. Maxim reserves the right to change the circuitry and specifications without notice at any time.

8 Maxim Integrated Products, 120 San Gabriel Drive, Sunnyvale, CA 94086 408-737-7600